

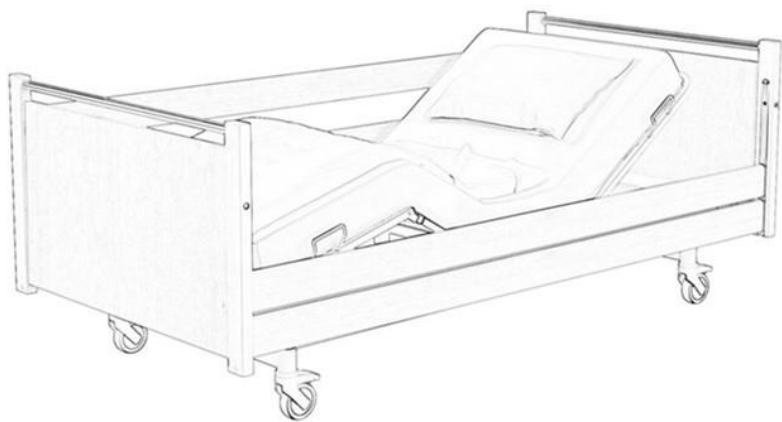

INSTRUCTIONS FOR USE

LEO



WELCOME TO REHA-BED

Reha-Bed is a Polish family company specializing in the production of the highest-quality rehabilitation beds and a wide range of products that support the care, rehabilitation, as well as long-term and short-term care.

Thanks to the fact that we not only produce and design our equipment but also are very flexible and can adapt to the requirements of our clients. Thanks to over 15 years of experience in the industry, we can advise our clients with full responsibility and help them to choose the most optimal equipment.

We meet the needs of our clients, search innovative solutions and constantly strive to expand our offer.

Reha-Bed Sp. z o.o. places the greatest emphasis on the high quality of components and materials used in production. It takes advantage of extensive experience and knowledge of world-class suppliers of actuators, driving systems and fasteners. The dynamically developing technology of our company ensures the highest quality of steel and wooden elements for the produced assortment. Precise control of our products is a guarantee of the future satisfaction of our clients.



R&D Department

Engineers, designers and constructors responsible for development, improvement and expansion of the range of products.



Production Department

Our production is based on modern world-class equipment and experience of our employees.



Employment

Over 50 qualified employees employed in the production department.



Area

Warehouse and production halls, as well as office space with a total surface exceeding 4500m².

CONTENTS

1. INTRODUCTION	4
1.1. CONTACT	4
1.2. TO WHAT IT CONCERNS?	4
1.3. FEATURES	4
1.4. USE	5
1.5. CONTRAINDICATIONS.....	6
2. WARNINGS AND CAUTIONS	7
2.1. GENERAL WARNINGS	7
3. TRANSPORT AND STORAGE	11
4. SYMBOL DEFINITIONS	13
5. PARTS	15
5.1. PARTS SPECIFICATION	15
6. BED ASSEMBLY AND PREPARING FOR USE	16
6.1. FITTING ELECTRICAL SYSTEM.....	16
6.1.1. HOLDER ARRANGEMENTS ON POWER CABLE	18
6.2. ASSEMBLING THE WOODEN BED ENDS ..	18
6.3. FITTING THE WOODEN, FULL-LENGTH SIDE RAILS.....	19
6.4. FITTING THE LIGHT SIDE RAILS	20
6.5. FITTING THE SPLIT SIDE RAILS.....	20
6.6. CHECKING THE BED.....	22
7. TRAINING	23
8. FIRST USE	24
8.1. OPERATIONAL LIMITS.....	24
8.2. GENERAL SAFETY.....	25
8.3. PREPARING FOR START	25
8.4. BRAKE SYSTEM	26
8.4.1. CASTORS WITH INDIVIDUAL LOCK	27
8.4.2. AXEL LOCK OF THE CASTORS	27
8.4.3. CENTRAL LOCK OF THE CASTORS .	27
8.5. SIDE RAILS AND MATTRESSES.....	27
8.5.1. SIDE RAIL SAFETY	28
8.5.2. MATTRESS THICKNESS.....	28
8.5.3. OPERATING THE WOODEN, FULL- LENGTH SIDE RAILS	29
8.5.4. OPERATING THE LIGHT SIDE RAILS	29
8.5.5. OPERATING THE SPLIT SIDE RAILS	29
8.6. ELECTRICAL OPERATION	30
8.6.1. HANDSET LOCATION	31
8.6.2. 10 AND 9-BUTTON HANDSET OPERATION.....	32
8.6.3. HANDSET LOCKOUT	33
8.7. LEG SECTION.....	33
8.8. BACK EMERGENCY LOWERING SYSTEM (CPR).....	35
9. DISASSEMBLING THE BED FOR TRANSPORT	35
10. POWER FAILURES	37
10.1. EMERGENCY LOWERING BACKREST AND LEG SECTIONS.....	37
11. DECONTAMINATION	39
12. MAINTENANCE	41
12.1. GENERAL MAINTENANCE	41
12.2. SERVICE LIFE	43
12.3. FAULTY FINDING	44
13. DISPOSAL OF PARTS	45
14. ELECTROMAGNETIC COMPATIBILITY (EMC)	46
15. SPECIFICATION	47
15.1. BED DATA	47
15.2. MAXIMUM LOAD.....	47
15.3. TECHNICAL DATA OF SIDE RAILS	48
15.4. ELECTRICAL DATA	49
16. ACCESSORIES	50
16.1. MATTRESS AND SIDE RAILS	51
17. LIFTING POLE	53
18. WARRANTY	54
18.1. WARRANTY CONDITIONS	54

1. INTRODUCTION

Thank you for your trust and purchase of our product. Before using the bed, please read this instruction manual carefully and make sure it is fully understood. In the case of any doubts concerning the installation, use or maintenance of the bed, please contact the seller or the manufacturer.

1.1. CONTACT

In order to get help with the installation, use or service of the product, as well as to report an unexpected operation or to obtain any information regarding service, warranty, sales or customer service concerning this product, please contact your seller, distributor or (in case of doubt) with Reha-Bed Sp. z o.o. at the following address:

Reha-Bed Sp. z o.o.
Spacerowa 1 Street
41-253 Czeladź
Poland

In service matters (including spare parts):

e-mail address: serwis@rehabed.com.pl

phone: +48 519 842 766

phone: +48 608 727 090

Other issues:

e-mail address: biuro@rehabed.com.pl

phone: +48 608 727 090

Each serious incident connected with the device should be reported to Reha-Bed Sp. z o.o. and the competent authority of the Member State, where the device is used. Please provide the product serial number (LOT) in all correspondence. You can find it on the identification labels, which are located on the inside of the backrest section frame and the leg section frame, as well as on the bottom of each bed ends.

In order to receive support outside of Poland, please contact the local distribution company, which sold you the device.

1.2. TO WHAT IT CONCERNS?

This instruction manual applies to Leo beds consisting of 4-section mattress platform with metal slats and electrically operated backrest and knee break.

All products are CE marked – in accordance with the EC Directive on medical devices (2017/745 (MDR)).

1.3. FEATURES

- 4 separate sections (movable back and leg section)
- Electrically controlled back and leg section position
- Mechanical adjustment of the foot section
- Auto contour – simultaneous adjustment of back and leg sections

- Stepless electric adjustment of bed's height and tilt: reverse-Trendelenburg and Trendelenburg* (available for hospital environment and nursing homes)
- Lockable handset (remote control)
- Wooden side rails or split side rails along the entire length of the mattress platform or steel Light side rails
- Emergency power system (optional)
- Electrical system IPX4 rated – Splash resistant
- Axel or central brake system (optional)
- Mechanical back section release system (optional).



*If patient requirements are such that Trendelenburg functionality is deemed to pose a potential risk a replacement handset can be purchased with the Trendelenburg function removed. Contact your seller or the manufacturer.

1.4. USE

The Leo bed with scissor-pantograph mechanism has been designed to provide the user with optimal independence and freedom whilst aiding the manual handling requirements of the carer. The Leo bed with a 9-button handset (Trendelenburg position locked-off) is intended for use within domestic environment. A 10-button handset is intended for use in the following environments in long-term care facilities, where medical care and health monitoring are required (e. g. nursing homes, rehabilitations centres, geriatric wards).

The bed significantly relieves a caregiver thanks to a fully electrically profiled platform that enables to adjust the position to the user's needs.

The bed is designed for users with a minimum height from 146 to 185 cm (when the bed length extension is not fitted), BMI greater than 17 and a maximum weight up to 178 kg. The lower (or upper) age limit is not defined. The usability of the bed depends on the physical size of the patient in relation to the various proportions and spaces around the bed's frame. It is not intended for patients weighting less than 40 kg.

The bed is intended for one person only!

The bed is designed to support the patient's weight (as described above) while sleeping or resting. It assists in the care and/or ensures comfort for the patient or caregiver – when the bed is used in long-term care facilities.

It is the carer's responsibility to determine that the patient is both mentally and physically capable of occupying the bed with minimal risk of personal injury.



- A risk assessment must always be performed on the suitability of the patient to the bed frame and any ancillary accessories.



- **If there are any doubts to use the product should be consulted with a health care professional (e.g. physiotherapist, doctor). Make sure the product is suitable for your condition or dysfunction.**

1.5. CONTRAINDICATIONS

The contraindications for using the Leo bed include:

- Cervical or skeletal traction,
- Unstable fractures of the spine – if the bed's functions remain unlocked,
- General fractures of the skeleton – if the bed's selected functions remain unlocked,
- Level of mental development that makes it impossible to safely operate the bed's functions – if the bed functions remain unlocked,
- Confusion, agitation or unstable emotional state of the patient – if side rails are installed and/or they are in the highest position,
- Exceeding the maximum patient's weight,
- Inadequate height of the patient (below 146 cm or above 185 cm),
- Inappropriate BMI of the patient (below 17),
- Inadequate weight of the patient (less than 40 kg).

Consider the presence of other contraindications that are specific for the patient of the care environment.

2. WARNINGS AND CAUTIONS



Warnings in this instruction manual indicate potential hazards, disregard of which could lead to injury or death.



Cautions in this instruction manual identify potential hazards, disregard of which could result in damage to the equipment.

2.1. GENERAL WARNINGS



- **READ THE INSTRUCTION MANUAL CAREFULLY** before use or installation.
- The user is obliged to observe this instruction.
- The bed is to be installed and put into service in accordance with the information provided in these instructions for use.
- The bed should be used in acceptance with its intended purpose.
- The bed is not suitable for children. If used by a child, ensure that a risk assessment has been conducted – taking into account the child’s proportions and the dimensions of the bed’s frame.
- The bed is not suitable for users with a height less than 146 cm – in case of doubt, please contact the local distributor, importer or manufacturer.
- The bed is not suitable for users weighting less than 40 kg – in case of any doubt, please contact the local distributor, importer or manufacturer.
- The bed is not suitable for users with a BMI less than 17 - in case of any doubt, please contact the local distributor, importer or manufacturer.
- Misused electrical equipment may be hazardous.
- Accessories that have not been designed for use with the bed should not be used.
- The use of additional mechanical or electrical devices that are not intended for use with the bed is unacceptable.
- Only original spare parts supplied by the manufacturer are allowed.
- The bed cannot be used if any screws/parts are missing.
- During transport, hold only the constant, massive parts of the bed ends!



- During assembly / disassembly and regular operation, particular attention should be paid to the risk of hand injury.
- Start and use of the defective device that could pose a risk to patients or others is forbidden.
- Actuators should not be used in the presence of flammable gases.
- The bed should be used and kept away from heat sources and open flames (e. g. cigarettes, electric fire, heaters, etc.) – risk of explosion / fire.
- It is forbidden to open covers of actuators, control box and power supply! Disassembly and seal break will void the warranty and create risk of electric shock!
- Particular attention should be paid to current wiring not being among movable parts of backrest / leg section and high / low system of the bed, which may cause malfunction.
- All lines must be suspended on dedicated brackets, so they are not frayed and do not touch the floor.
- Ensure that mains cable is plugged into an appropriate power source at all times.
- The mains plug is the disconnect device for the means of isolating the bed from the mains supply, the plug must be accessible at all times.
- Pulling the plug out of the socket is permissible only for holding the body of the plug / adapter, not the cord.
- Inappropriate handling / positioning of the mains cable could cause kinking or shearing of the cable which may lead to exposed live wires - risk of electrocution.
- If you cannot plug the main power cable directly into a wall socket, only the CE marked extension cables may be used.
- If the product is connected to the power supply with an extension cable, never overload the product by connecting devices that exceed the maximum rating of the extension cable – risk of fire.
- Make sure that there are not many sockets under the frame – liquids that may seep into such a socket during normal use of the bed may pose electrical/fire hazard.
- The place of use of the bed there should be no obstacles to the proper operation or installation.
- Setting up and using the bed should be on flat, horizontal surfaces so that all the castors touch the ground.
- Before each use, check the bed and lock all four wheels.
- Wheels should be locked/unlocked by foot, not by hand.



- The bed should be in the lowest position if the patient is left unattended, in order to minimize the risk of injury caused by a fall.
- A handset must be locked if the patient should not change the height and/or tilt of the back and/or leg sections, or when there are doubts concerning the patient's ability to safely control the functions of the bed.
- In the absence of supervision of the patient (if such circumstances occur), the bed should be set to the highest position of railings on both sides of the bed. Unlocking and lowering them can be done only by the person responsible (care person or nurse).
- The patient should not be left in the Trendelenburg or reverse Trendelenburg position!
- The bed is not intended for patient's transportation. The manufacturer allows moving the bed with patient within the room to clean or gain access to the patient. In such a case, special attention should be paid to disconnect the bed from the power supply before transporting the bed. The transportation should take place in the lowest position of the mattress platform while maintaining the patient in the horizontal lying position.
- Side rails must be installed on both sides of the bed (on the side of the wall as well).
- Standard height side rails enable to use mattresses with a maximum height of 150 mm.
- The height extension of the side rails enables to use mattresses with a maximum height of 270 mm.
- Side rails may only be used with proper size mattresses intended for the bed – otherwise there is a risk of the user entrapment.
- Leaning against or resting on rails may cause accidents!
- Leaning out of the bed is a threat of injury!
- In case of damage to the rails (bending, breaking, cracking etc.), they should be immediately replaced with new ones due to the risk of an accident.
- Placing limbs between the moving elements of the bed may cause injury and accidents.
- Do not exceed the safe working load of the bed!
- Maximum operating time of actuators is **2 minutes for 18 minutes break**. Failure to comply with the afore-mentioned will result in permanent damage to the actuator.



- During the adjustment and maintenance attention should be paid to ensure that no part of the body is found in the potentially hazardous section (movable: backrest section, leg section, high / low system, side rails, optionally attached CPR system) - risk of injury to the limbs!
- Particular attention should be paid to small children, the patient's limb or other items around the bed that could entrap in a space between mattress platform and the chassis and be damaged or injured.
- Do not sit on the raised sections of the back, thigh and lower leg.
- Bear in mind that self-repair poses a risk of accidents or damage to the bed!
- Maintenance, repair and disinfection may be conducted only by specially trained persons.
- It is forbidden to modify the bed's frame without the consent of the manufacturer – this poses a risk of danger.
- Precautions are to be taken when routing cables from external equipment around the bed to ensure that they do not become squeezed, trapped or damaged - risk of electric shock and/or fire.
- All electrical components that are a part of the bed and/or related accessories, which are damaged, must be immediately withdrawn from service and replaced – damaged electrical components may present a risk of electric shock/fire.
- If the bed will be used with a hoist, make sure that there is enough space under the bed to lower the bed to the lowest possible position of the mattress platform – risk of crushing of the bed's frame.
- Due to the small space under the bed, special attention should be paid to young children, user limbs and other items around the bed that could be trapped between the bed's components and injured or damaged.
- The RF emissions from the electrical system are very low and are not likely to cause any interference to nearby electronic equipment, however interference to sensitive equipment is possible (see section 14 for further detail).
- Deformed lifting pole should be promptly replaced.
- **ALL THE ABOVE WARNINGS AND CAUTIONS SHOULD BE STRICTLY ADHERED TO.**

3. TRANSPORT AND STORAGE

The following conditions should be followed when transporting and storing the bed:

- Bed always to be stored on a flat and level floor.
- Bed ends set to minimum height.
- Side rail components (not including wooden side rails) to be kept in the aluminum channels on the bed ends (or stored safely together).
- Wheel brakes should be applied.
- All profiling sections secured with hook and loop tape (or similar).
- All electrical functions of the bed locked out.
- Make sure that all fasteners (such as screws, washers, plugs, etc.) are carefully tightened and secured for transport.
- Covered to protect from fluid ingress, dirt, dust etc.
- Beds must not be stored one on top of another.
- Beds not to be stored on their side.

Environmental conditions:

	Operational Limits	Transportation/storage limits
Ambient temperature:	from +10°C to +40°C	from -20°C to +50°C
Humidity:	30% - 75%	30% - 75%
Atmospheric pressure:	from 800 to 1060 hPa	from 800 to 1060 hPa
Altitude:	≤ 2000 m	≤ 2000 m



- The bed is not intended for patient transport, it is not to be moved out of the room it is located in with a patient occupying the bed - Risk of patient / carer injury. If the bed is to be moved within the room with an occupant in the bed a risk assessment in line with local health and safety policy is to be undertaken in order to ensure that neither staff or patients are put at risk when moving the bed; this is dependent on the situation and load on the bed.
- If transporting the bed ensure a risk assessment in line with local health and safety policy is undertaken to ensure that staff are not put at risk when moving the bed, especially in regards to moving up / down inclines and uneven surfaces.
- The bed should not be transported if any screws are missing or sections are not secured - risk of the bed collapsing.
- In order to prevent the risk of cross contamination, when removing the bed from its place of use by the end user, make sure that all actions (connected with the bed) are carried out with the use of disposable gloves. Next to, properly dispose the glove, unless it can be verified that the bed and all accessories have been properly disinfected and cleaned.



- If the bed is removed from its place of use by the end user, before handing the bed over for storage, make sure that the bed has been cleaned and disinfected – in acceptance with your local infection control rules and/or rules that are specified in this instruction manual (see section 11).



- If the bed has been transported/stored at a temperature close to the minimum/maximum values determined above, it should be left for a minimum of 2 hours in order to reach room temperature before its connection to the power supply – operation outside the recommended temperatures poses a risk of damage to the electrical system.
- Avoid exposing the bed to direct sunlight – direct sunlight may damage the electrical system and/or cause bed's colour fading over time (including the fading of the bed's labels).
- Avoid placing the bed in a humid environment – a long-term exposure to moisture may damage the electrical system and/or have a detrimental effect on parts of the bed's frame.
- Do not use side rails to transport the bed – risk of damage.
- Do not transport the bed over threshold – risk of damage.
- When using the bed's functions, make sure that no furniture or other things (such as a bedside table) are not an obstacle.
- Make sure that the bed is positioned in an appropriate distance from walls/other furniture in order to prevent the damage to the equipment when operating the bed (especially when working with a tilted mattress platform).
- Cable tiles, etc. used for storage should be removed after assembling the bed, before use – the frame may be damaged in the event of their leaving.
- Take special precautions concerning EMC. The bed should be installed and put into operation in a manner described in section 14.
- The bed with an additional source of emergency power supply is not intended to discharge batteries for a long time and it should always be connected to the power supply during normal use – complete discharge may reduce their performance.

4. SYMBOL DEFINITIONS

The following symbols are observed on the beds:



Warning
Beware of potential hazard



Cautions
Beware of potential hazard



Refer to instructions for use – recommended
Failure to read the instructions for use could introduce a hazard



Refer to instructions for use – mandatory
Failure to read the instructions for use could introduce a risk



Maximum patient weight
Refer to section 15.2



Safe working load
Refer to section 15.2



WEEE marking - placed on individual parts of electrical system
(Waste electrical and electronic equipment) – see section 13



Application part (type BF)
Application part: a part of the device that comes into physical contact with the patient and/or user – in order to use it to perform its assigned functions (see section 15.4)
Type BF: application parts that are electrically isolated from earth and other parts of medical equipment – they comply with the specific requirements for protection against electric shock in acceptance with IEC 60601-1.



Class II electrical appliance
The user is protected by at least two insulation layers against conductive elements (e. g. power cable) – in case of noticing damage to the control unit or the power cables, immediately disconnect the device from the power supply and immediately contact the supplier or Reha-Bed Sp. z o.o.



Marking of the medical device

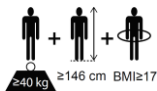

Determination of minimum physical requirements for adults
From the left: minimum patient weight, minimum patient height, minimum BMI value of the patient



Mattress suitability
Refer to section 16.1

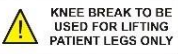

Warning – knee break intended purpose
Knee break to be used for lifting patient legs only

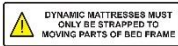

Warning – dynamic mattress

Dynamic mattresses must only be strapped to moving parts of bed frame



Reference No.	Current Date	Current Serial Number
00000000000000000000	2023-01-01	00000000000000000000
00000000000000000000	2023-01-01	00000000000000000000
00000000000000000000	2023-01-01	00000000000000000000
00000000000000000000	2023-01-01	00000000000000000000

Electrical specification

Including storage and use conditions

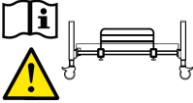

Warning – removable side rail

Incompatible and improperly installed side rails may pose a risk of injury or death - see the instruction manual



Total product weight in transport mode

Heavy weight of the product - be careful when transporting on the transport stand and assembly



Certification mark

Product meets the requirements of the EC Directive on medical devices (2017/745 (MDR))



Manufacturer data



DOM

Date of manufacturing



LOT

Serial number



Reference number

Product code

5. PARTS

5.1. PARTS SPECIFICATION

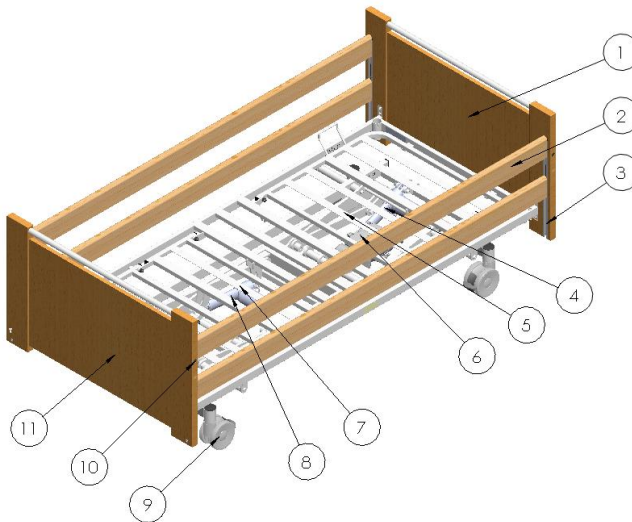

(The figure shows the Leo bed with wooden side rails)

1. Head end
2. Side rail
3. Side rail channel (aluminum channel)
4. High / Low actuator
5. Backrest mattress platform
6. Backrest section actuator and control box
7. Leg section frame
8. Leg section actuator
9. Castor
10. Side rail release button
11. Foot end
12. Handset (not visible)
13. Lifting pole (optional, not visible)



- During assembly / disassembly and regular operation, particular attention should be paid to the risk of hand injury.
- The bed cannot be used in case a screw is missing.

6. BED ASSEMBLY AND PREPARING FOR USE



- Before attempting to assemble the bed, ensure these instruction manual has been read and fully understood.
- Ensure a risk assessment in line with local health and safety policy is undertaken to ensure that staff are not put at risk when performing assembly activities.
- Pay special attention during assembly activities due to the heavy weight of individual elements.
- The manufacturer recommends that the bed should be assembled by two persons.

For assembly, clear the intended area, paying particular attention to the fact that any movement of the bed will not be obstructed.

Apply the brakes to the castors.

6.1. FITTING ELECTRICAL SYSTEM

The bed is designed to be connected to a constant power supply at all times during use. An auxiliary emergency power supply is available as an accessory to maintain the bed's basic functions for a specified period of time if mains power is not available (see section 10).

- The bed is delivered with fitted electrical system - the cables are matched to the graphic on the control box with coloured tags. Ensure the cables are connected correctly into the corresponding ports.

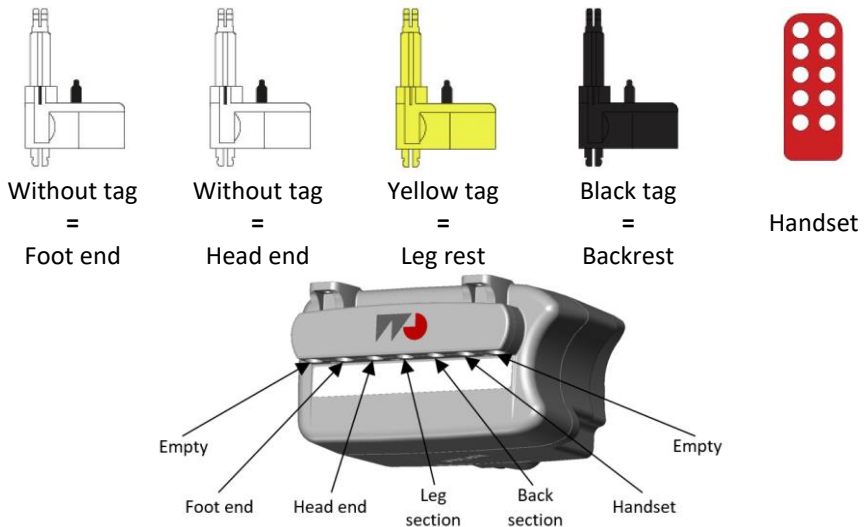

Note: The two bed ends are identical but plugging them into the correct port is important for the tilt function to work as intended.

- Check condition of power cable, handset cable and actuators' cables and make sure they are not damaged.



Note: Actuator and handset cables are not shown
(Image courtesy of DewertOkin GmbH)

- Once all the cables are connected they are to be secured in place by attaching the retaining clip.

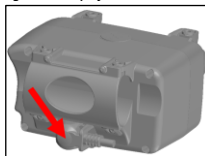

Actuator is not shown
(Image courtesy of DewertOkin GmbH)

- Connect the mains cable into the socket on the bottom of the control box, and then plug the power adapter to the mains system.
- Clip the mains cable into the additional cable holders (see section 6.1.1).
- Make sure that actuator cables have sufficient length and they are not over-tightened – the full range of movement for actuators should be possible.



- Make sure that none of the actuator and/or handset cables are placed between moving parts of the bed and are not under excessive tension, and check that cables are not tight (especially the main power cable when lifting the bed up and down and/or backrest section control cable) to avoid possible damages. Damaged cables pose a risk of electric shock and/or fire.
- Make sure that both actuators (high/low) are plugged into the correct ports. If the Trendelenburg or reverse-Trendelenburg function does not work as expected, the high/low actuators can be connected in a wrong way.
- Untightening and break the seals or lid of the actuators, the control box or the power supply will create risk of electrocution and void the warranty.



- Ensure all cables, in particular the mains cable, are free from moving parts and are not under excessive tension.
- Pulling the plug out of the socket is permissible only for holding the body of the plug / adapter, not the cord.
- Damage to actuators or the control box will void the warranty.
- Breaking or damaging seals of actuators or the control box will void the warranty.

6.1.1. HOLDER ARRANGEMENTS ON POWER CABLE

Leo bed is equipped with 7 additional cable holders that allow the power cable suspension under the mattress platform.

The figure below presents the arrangement.

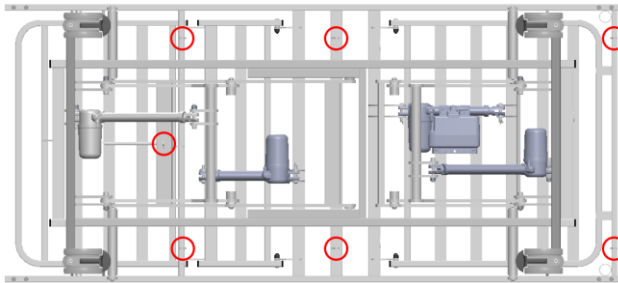

- All cables must be suspended from the platform frame on dedicated brackets, to avoid rubbing and cannot touch the floor.
- Incorrect placement/deployment of the power cable may cause the damage or cut of the cable – this situation may expose live conductors (risk of electric shock).
- Consider the adequate placement of actuator and/or handset cables in order to minimize the risk of accidental suffocation as a result of the entanglement of the user and/or other people.

6.2. ASSEMBLING THE WOODEN BED ENDS

- **Note: If this action is being undertaken the manufacturer recommend that the castors are braked before assembly commences.**
- Fit bed end sliding the spigot into the platform end and determine the position of the set screws.
- Tighten all set and dome head screws, making sure the set screws are tightened before tightening the dome head screws.
- Repeat for the other bed end.
- Cut off/remove the plastic retaining ties/Velcro straps from the head and foot mattress platforms.

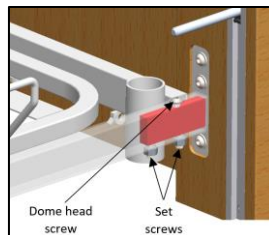
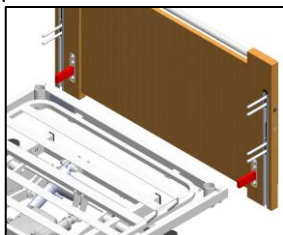

6.3. FITTING THE WOODEN, FULL-LENGTH SIDE RAILS

Before installation, make sure that the length of side rails is suitable for the length of the mattress's platform (see section 15.3).

- Lower/raise the bed to its medium height (see section 8.6.2 regarding the operation of the bed's electrical functions).
- Depress each end's side rail release button (see section 8.5.3) and lower the finger assemblies to the bottom of the channel.
- On the foot end, remove the retaining screw at the bottom of the side rail channel on one side. **Do not remove head end retaining screws.**

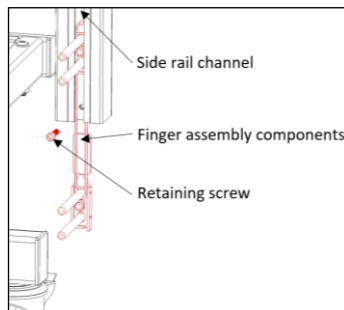

- Remove the finger assembly from the channel.
- Take two side rails (rounded face pointing upward) and slide the end of them into set of fingers that is still located in the channels at the head end of the bed. Carefully rest the unattached ends on the floor taking care to ensure that the other ends are sufficiently far into the fingers so that they will not fall out.
- Take the previously removed finger assembly, place the lift wire over the top finger set (as shown in the picture below) and insert into the other end of the top side rail. Slide the finger assembly inside the channel. **It is recommended that a second person holds the rail at this point.**

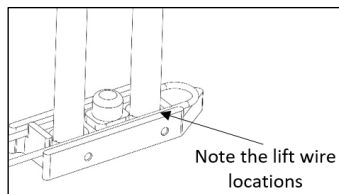
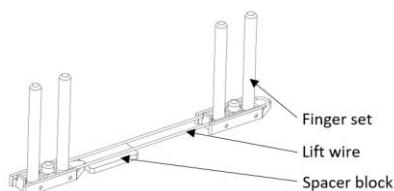

- Whilst holding the top side rail, slide the plastic spacer block into the channel and place the upper finger of the bottom finger set through the hole in the lift wire (as shown in illustration to the right) and into the other end of the lower side rail and lift the assembly until a click is heard.
- Re-fit the previously removed retaining screw. This ensures that the side rail finger assembly cannot fall out of the channel when in the lowered position.

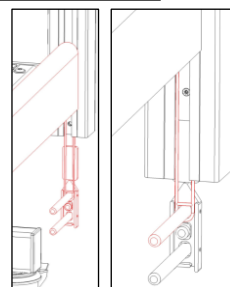

- Repeat the assembly process for the side rails on the other side of the bed.
- Check that the side rails function properly and smoothly. Check that the side rails easily lock into the highest position to make sure that they are mounted in a right way.

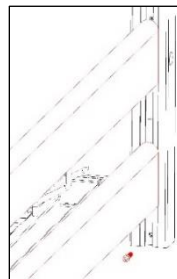

6.4. FITTING THE LIGHT SIDE RAILS

The Leo bed is delivered with fitted steel Light side rails. The following instructions may be helpful when you need to replace the side rails or their components.

- To fit the Light side rails, fix it to the bed according to the below picture, setting it evenly on both mounting sleeves.
- Pay attention that the side rails release button is closer to the foot bed end. Note: the side rails are the same for the right and left sides of the mattress platform and they may be installed interchangeably.

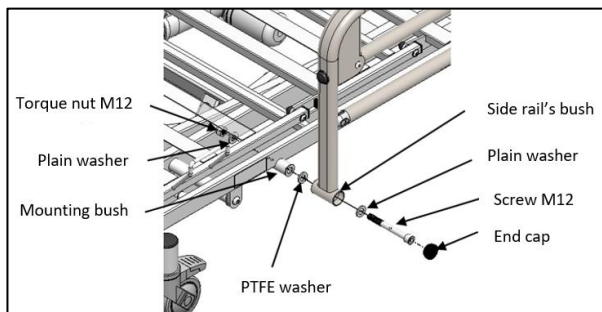
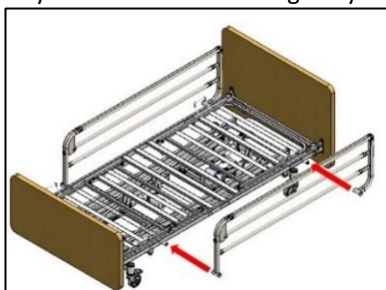

6.5. FITTING THE SPLIT SIDE RAILS

The Leo bed is delivered with fitted split side rails. The following instructions may be helpful when you need to replace the side rails or their components.

- Prepare the dome head screws and the Ericson nuts.

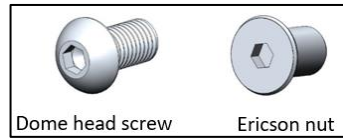

- Place the Ericson nuts in the holes from the inside of the mattress platform (3 pcs.) in the place where the side rail will be fitted.

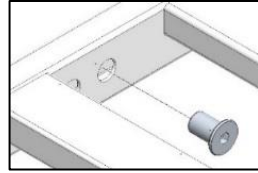

- Prepare a side rail and place it on the mattress platform.
- **Note: the side rails are available in the right or left and long or short version!** Make sure that the side rail release button (shown below) is closer to the center of the mattress platform.

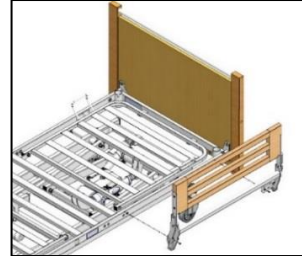

- Use the dome screws and fix the side rail to the bed.
- Repeat the above steps for the other side rails.



- If there is any doubt about the assembly contact the provider or manufacturer, incorrectly fitted side rails can lead to death.
- Side rails must be installed on both sides of the bed (on the side of the wall as well).
- With standard side rails, the maximum height of the mattress is 150 mm.
- In case of damage to the rails (bending, breaking, cracking etc.), they should be immediately replaced with new ones due to the risk of an accident.

6.6. CHECKING THE BED

The bed is now fully assembled. Before the bed is put into use ensure the bed is correctly assembled:

- Ensure the correct side rails are fitted to the bed, refer to section 15.3.
- Are the set and dome screws on all 4 corners of the bed fully tightened?
- Are the retaining screws for the side rails mechanisms inside the aluminium channel fully tightened?
- Has all packaging been removed, e.g. cable ties securing the platform sections?
- Are the cables free of all moving parts and is there sufficient slack in the cables to allow for movement?
- Is the bed clear of obstructions?
- Do the side rails raise / lower smoothly and lock automatically in the raised position?
- Has a risk assessment been performed on the suitability of the bed (and any ancillary equipment) for the user?
- Has the control box cable retaining clip been attached?
- Are plugs of actuators and power cable in the power box secured with the provided cover cap?
- Has the mains cable been secured to an auxiliary holder under the mattress platform?
- Has the bed (if necessary) been cleaned and disinfected before use?
- Has the function of the emergency lowering of the back platform (CPR) been checked?

In order to find details about the side rails and the mattress see section 16.1



The bed cannot be used in case any screws are missing.



Make sure that all retaining straps have been removed from any bed parts. If not, the bed can be damaged.

7. TRAINING

Professional personnel should be appropriately familiarized with the functionality of the bed, its limitations and the target user group before use. The user's ability to operate the handset in an independent manner should be determined in acceptance with the risk assessment. The user should be familiarized with the handset and the functionality of the bed by a trained person as soon as possible – preferably before the use of this product. It is the responsibility of the end user to ensure they have received sufficient training to use the bed and any associated accessories safely and correctly.

It is the responsibility of the trained person to ensure that users are able to use this bed and any additional accessories in a safe and proper way. If the above-mentioned instructions are not sufficient and additional training is required, please contact your local provider or producer (see section 1.1), who is authorized to discuss training options.

8. FIRST USE

Prior to using the bed for the first time the following risk assessment must be performed based on the status of the patient and their body. This assessment should include, but is not limited to:

- The possibility of patient entrapment
- Fall out of bed
- The possibility of interference from children (and adults)
- Patients with learning disabilities
- Unauthorized persons
- Physical and mental condition of the patient
- Housing conditions
- Use of side rails and other accessories



- After assembling the bed, there should be no unused parts. However, the presence of spare parts (pins, holder, screws, etc.) should be taken into account to minimize the risk of ingestion by the patient, who use the bed and/or other persons – risk of choking.
- Functions of the bed should be blocked if there is any doubt regarding the patient's ability to safely operate the bed.
- Prior to each operating the bed ensure the brakes on all the castors have been applied.
- It is forbidden to start and use the product with defects that may pose a risk to users or other persons.
- If children, adults with reduced cognitive/learning abilities or (even) pets pose a potential risk of intentional or unintentional manipulating the bed, consider its suitability for use during the initial risk assessment of the patient/product.
- The bed does not meet the height range and underbed clearance requirements for the IEC 60601-2-52 standard - the potential risk is implemented by the requirements of the patient of caregiver.

The bed lift (made of powder-coated steel) support the mattress platform, electrical system and a set of side rails to ensure patient's safety. The safe working load is 215 kg. The bed is equipped with 4 lockable wheels to allow manoeuvring the bed. However, the bed is not intended for transport of the patient.

8.1. OPERATIONAL LIMITS

- Ambient temperature: +10°C to +40°C
- Humidity: 30% - 75%
- Atmospheric pressure: 800hPa to 1060hPa (altitude ≤ 2000m)

8.2. GENERAL SAFETY

- When the bed is operated, make sure that objects such as a bedside table or other furniture are not an obstacle.
- Before exploiting the bed, make sure that the patient has been positioned correctly.
- When the patient is left unattended, make sure that the bed is set at the minimum height.
- Keep distance of min 15 cm from the walls.
- Make sure all cables are not under excessive tension.
- If the bed is being used in conjunction with a hoist ensure the under bed clearances are checked before lowering the bed to minimum height - risk of frames clashing.
- Make sure that every used mattress is the right size and has been filled correctly.



Placing the limbs or other objects between the moving parts of bed may cause damage or accident.



Only medical mattresses are allowed. Using other types of mattresses may cause damage to the bed.

8.3. PREPARING FOR START

Prior to using the bed for the first time:

- Ensure the bed and all accessories are at room temperature.
- Ensure the bed has been cleaned and disinfected (see section 11).
- Ensure the mains cable is plugged appropriately.
- After plugging the bed into the mains supply it was not attempted to operate at least 10 seconds, to allow the control system to initialise itself.
- Ensure the brakes on the castors have been applied:
 - **Note:** Before locking the wheels, make sure that they are parallel to the length of the bed and inwards – they cannot pose a tripping risk.
 - **Note:** All four wheels should be locked to eliminate the accidental movement of the bed.
- Ensure the bed is level, placed horizontally, on the flat surface so all the castors touch the ground and all electrical functions controlled by handset work properly.
- Ensure the handset's functions are locked/unlocked (depending on the assessment of the patient's condition and the environment – see section 8.6.3).
- Ensure that all electrical functions controlled by the handset work correctly.



- If electrical functions do not work properly, make sure that the handset is unlocked (see chapter 8.6.3).
- The bed is to be left in its lowest position when the patient is unattended in order to reduce the risk of injury due to a fall.
- Before operating the bed ensure the patient is positioned appropriately ensuring all limbs are clear of moving parts.
- Consideration is to be taken in the positioning of the bed cables and handset cable to minimise the risk of accidental strangulation resulting from baby, child or bed occupant entanglement.
- Ensure that any mattresses used are of the correct size and type and have been fitted correctly – Incorrect mattress specification could lead to an entrapment and / or falls hazard.
- Ensure the mattress is compatible with the side rails (if fitted).
- The patient should not be left in the Trendelenburg or reverse Trendelenburg position!



- Only medical mattresses are allowed. Using other types of mattresses may cause damage to the bed.
- Ensure the bed is positioned an appropriate distance from walls / other furniture to prevent damage or patient injury when operating the bed (particularly when operating it in tilt).

8.4. BRAKE SYSTEM

The LEO bed can be equipped with a castors with individual lock, axle lock or central lock (optionally with a direction lock).

For safety reasons, wheels should be blocked with the foot (not with the use of a hand), and the manufacturer recommends wearing adequate footwear.

During normal use, all wheels should be locked.



- Castors should be locked / unlocked by foot, not by hand.
- If the bed is to be pushed up / down a slope it is advised that two people move the bed, with one person at each end.
- If the bed is to be pushed with a heavy load it should be assessed whether or not two people should move the bed, this is dependent on the situation and load on the bed.

8.4.1. CASTORS WITH INDIVIDUAL LOCK

The bed has 4 braked castors. The individual lock enables locking a single, selected castor.

- To apply the brakes: Press the brake pedal down.
- To release the brakes: Lift the brake pedal up.

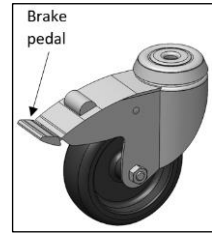

8.4.2. AXEL LOCK OF THE CASTORS

The axel lock allows to lock simultaneously 2 parallel castors (in the axis along the short side of the bed).

- To apply the brakes: press the brake pedal down on one of the two wheels on the short axis of the bed.
- To release the brakes: lift the brake pedal up to a horizontal position, parallel to the ground of one of the two castors on the axis.

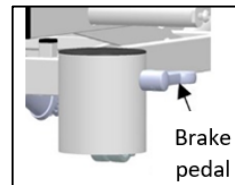

8.4.3. CENTRAL LOCK OF THE CASTORS

The central lock allows to lock all 4 wheels simultaneously. Optionally, the central wheel lock can be equipped with a direction lock.

- To apply the brakes for all castors: press the one, chosen brake pedal down from the bed ends' side (outer side of the bed).
- To apply the direction lock: press the one, chosen brake pedal down from the center of the mattress platform (inside of the bed).
- To release the brakes for all castors or the direction lock: lift the one, chosen brake pedal up to a horizontal position, parallel to the ground.

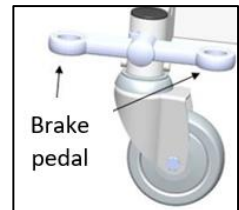

8.5. SIDE RAILS AND MATTRESSES

Leo bed comes as a standard with a full length side rails. Wooden rails extend over the entire length of the bed. Additionally, you can order a height extension to wooden rails.

Characteristics of the mattresses and the side rails tested and approved by the manufacturer can be found in the section 16.1.



- Ensure that any mattresses used are of the correct size and type and have been fitted correctly – Incorrect mattress specification could lead to an entrapment and / or falls hazard.
- Ensure the mattress fitted is used with a compatible side rail.

8.5.1. SIDE RAIL SAFETY

Manufacturer only recommends the use of manufacturers side rails with this bed. Manufacturer does not recommend the use of the Leo bed and side rails when caring for individuals who are less than 146cm in length - It is the equipment provider's responsibility to ensure suitability for use.



- Whilst every care has been taken to ensure that the design of the side rails meet the relevant safety standards, beds fitted with side rails can still pose a potential risk of death from entrapment and asphyxiation.
- All staff responsible for the purchase, selection for use, and adjusting of bed side rails should be aware of the potential risk of entrapment and asphyxiation when a bed is occupied.
- Care must be taken when positioning and adjusting bed side rails to ensure that any spaces between the bed side rails, mattress or bed frame will not allow entrapment of the occupant's head or body. In addition, consideration should be given to the size and physiological condition of the occupant and an assessment undertaken to ensure that the spacing between the bars of the bed side rails is not wide enough to present a potential risk of entrapment and asphyxiation. All staff responsible are to be aware that increased vigilance is required when nursing patients in beds fitted with bed side rails.

8.5.2. MATTRESS THICKNESS



- With standard length side rails the approved maximum mattress height is 150 mm.
- With side rails with height extensions, the mattress maximum height is 270 mm.
- Side rails must only be used with proper size and type mattresses approved for use with Leo bed.
- The use of side rails that have not been approved for use with the bed is unacceptable due to the risk of loss of health or life.

8.5.3. OPERATING THE WOODEN, FULL-LENGTH SIDE RAILS

To lower side rails:

- Lift the side rails gently, vertically upwards.
- Press the release button for side rails.
- Gently lower the side rails (the release button can be let depressed when lowering side rails).

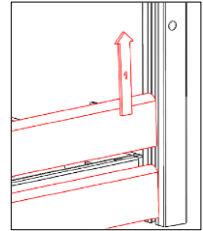
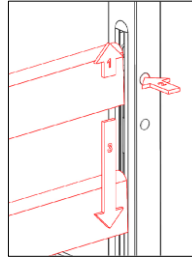

To raise the side rails:

- Lift the side rail until it is heard to latch into position at the top height.

8.5.4. OPERATING THE LIGHT SIDE RAILS

To lower side rails:

- Pull the side rails gently towards head bed end.
- Press the release button for side rails.
- Gently lower the side rails (the release button can be let depressed when lowering side rails).

To raise the side rails:

- Lift the side rail until it is heard to latch into position at the top height.

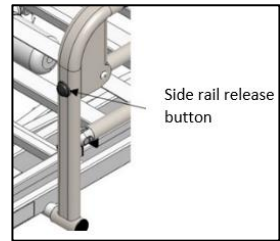

8.5.5. OPERATING THE SPLIT SIDE RAILS

To lower side rails:

- Pull the side rail's release button.
- Gently move the side rail until the lock disengages.
- Gently lower the side rails (the release button can be let depressed when lowering side rails).

To raise the side rails:

- Lift the side rail until it is heard to latch into position at the top height.

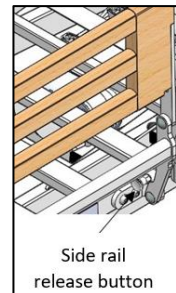

- When in the raised position, ensure the side rails are locked in place at all times in order to avoid trapping and/or injury.
- Before using side rails, make sure that no limbs or objects are placed between side rails due to the risk of trapping and/or injury, as well as damage to side rails or the bed's frame.
- Side rails are not designed to support the patient.
- Side rails are not designed to be used as a patient's lifting aid.
-



- When operating the side rails ensure they are free from obstructions, to prevent injury or entrapment.
- When leaving the bed, do not hold the side rails – risk of trapping /crushing finger(s) when the weight of the patient’s legs causes side rail’s bending and closing the gap between side rails.
- In the absence of supervision of the patient (if such circumstances occur), the bed should be set to the highest position of side rails on both sides of the bed. Unlocking and lowering them can be done only by the person responsible (care person or nurse).



- Do not use side rails to transport the bed – the risk of damaging side rails/bed’s frame.
- Do not use side rails as a positioning and/or lifting aid – the risk of damaging side rails and/or the bed.
- When lowering do not drop the side rail.

8.6. ELECTRICAL OPERATION

Leo bed has been equipped with a 9-button or 10-button easy-to-use handset. It is intended for use by both the patient and the caregiver. However the handset should be operated by the care person. During the operation of the bed position by the caregiver, make sure that the user is informed about the change in the position of the mattress platform.

Thanks to the use of the handset, it is possible to control the electronic, linear system of actuators, which are controlled by the central control box. Actuators are attached to moving parts of the bed’s frame. This enables to change their position with the use of the handset. Pressing the appropriate button activates the selected function, and releasing completes the operation and stops all movements. The caregiver has the option of blocking the bed’s functions (if necessary) in order to reduce the risk of accidental and/or unintentional operation of the bed. The caregiver is responsible for determining whether the patient is mentally and physically able to operate the bed’s functions with a minimal risk of injury or damage to the body.

During the operation of the handset by the care person, it should be ensured that the user is informed about the change in the position of the mattress platform.

It is recommended to use 9-button handset in a home environment.



- Ensure a risk assessment is undertaken to ensure the suitability of the occupant or visitor using the handset.
- The handset cable must also be considered in regards to the risk of accidental strangulation of the bed occupant or visitors – If the cable introduces an unacceptable risk it is recommended that the handset is removed from the bed.
- Before lowering the bed ensure nobody is in close proximity to the underside of the bedframe – risk of crushing.
- Before lowering the bed ensure feet / limbs are kept away from the castor pedals / corner posts (long wooden ends of the bed ends) - risk of crushing.
- It is forbidden to use any glowing or burning objects (candles, cigarettes, etc.) in the bed's area – the risk of damage to the electrical system leading to a fire.
- It is forbidden to use actuators in the presence of flammable gases and/or in oxygen-rich environments due to the risk of explosion/fire.
- For safety reasons, in a domestic environment, it is recommended to use a 9-button handset (without the function of tilting – head down).



- If the bed is continuously used for an extended period of time and it exceeds the duty cycle the control box and / or lift actuators may become temporarily disabled or irreparably damaged. If this occurs remove the power supply from the wall and allow system to rest for 20-30 minutes before attempting to re-operate.

8.6.1. HANDSET LOCATION

The handset should be hung on the side rails with extreme caution taken to the cable leading to the control box.





The manufacturer recommend that the handset is positioned on the side rails with all functions locked out when the patient is left unattended to minimise the risk of unauthorised operation and accidental strangulation.

8.6.2. 10 AND 9-BUTTON HANDSET OPERATION

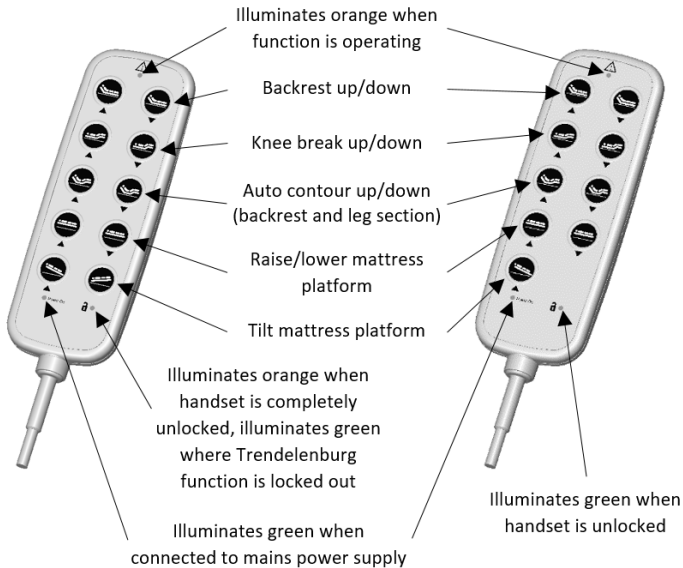

Note: when the bed is in the tilt position (even if the Trendelenburg function is locked), levelling the mattress platform is carried out through the adjustment of the mattress platform high, by lifting the platform upwards (maximum value) or lowering down (maximum value) – until the mattress platform is levelled.



- Engage the lockout function if a patient could be injured due to inadvertent motion of the mattress platform.
- If children, adults with learning difficulties or even pets pose a potential risk of intentional or unintentional tampering with the bed the lockout function on the handset is to be used at the discretion of the carer.
- The bed is not fitted with a battery backup facility, so it must always be plugged into the mains supply during normal use.
- Consideration is to be taken in the storage of the handset lockout key to minimise the risk of it being swallowed by a baby, child or the bed occupant and creating a choking hazard.



- Consideration is to be taken in the location of the handset lockout key to minimise the risk of unauthorised users changing the lock setting.
- If patient requirements are such that Trendelenburg functionality is still deemed to pose a potential risk a replacement handset can be purchased with the Trendelenburg function removed. To order the handset or to request further information please contact your seller or the manufacturer.

8.6.3. HANDSET LOCKOUT

The handset is supplied with a lockout function which enables the care person to disable the handset with a mechanic key (functions or the Trendelenburg function - only in the case of 10-button handset) until the light is on/off. The key is attached to the bag with the Instruction For Use. The use of the handset lock function depends on the caregiver's decision.

To lock/unlock the handset: turn the handset over, put the key in the recess on the back of the handset, turn the key (fully) clockwise to lock or counter clockwise to unlock functions.

To lock/unlock the Trendelenburg function (only in the case of 10-button handset): turn the handset over, put the key in the recess on the back of the handset, turn the lock to the place indicated in the picture on the right.

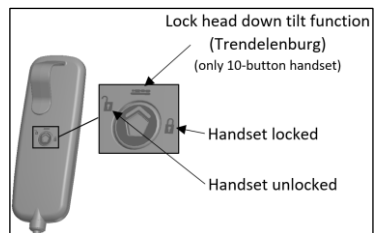

Note: Functions of the handset should be disabled when the bed is put into service.



Engage the lockout function if a patient could be injured due to inadvertent motion of the mattress platform.

8.7. LEG SECTION

Note: The operation of the leg section is dependent on the position of the ratchet as detailed below.

The bed is fitted with an adjustable leg section. When the leg section function on the handset is operated the height or angle of the leg section is adjusted, depending on whether or not the leg section ratchet is set.

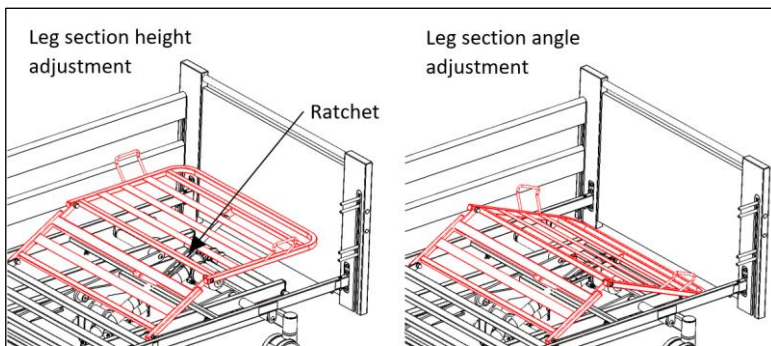

Setting the bed so that the leg section height adjustment operates:

- Press the leg section button on the handset and raise to maximum height.
- Lift the leg section manually with the use of handles so that the ratchet engages (once engaged the leg section will be supported by the ratchet).
- The leg section will now move parallel to the bed frame as it is driven up / down with the use of the adequate function on the handset.
- Once the leg section has been fully lowered the leg section will default back to angle adjustment only.

Setting the bed so that the leg section angle adjustment operates:

- Press the leg section button on the handset and raise the leg section (height not important).
- Lift the foot section manually so that the ratchet disengages (if in doubt lift the leg section to the ratchet's maximum extent).
- Gently lower the leg section down.
- The leg section angle adjustment will now be set.

Note: To unlock (reset) the ratchet, use handles to lift the thigh section to the maximum position.



Warning

Before attempting to lift the leg section either:

- Ensure there is no load on the foot section, or
- Support the foot section with a second able bodied person.



Caution

The leg section is only to be used for the lifting of a patient's legs – any other use may damage the bed frame.

8.8. BACK EMERGENCY LOWERING SYSTEM (CPR)

Optionally, the LEO bed can be equipped with an emergency lowering system for the back section. This equipment operates independently of the power supply.

Two handles are mounted on the bed (on both sides of the bed) in the middle of the mattress platform. After pulling the handle, the mattress platform is immediately lowered.

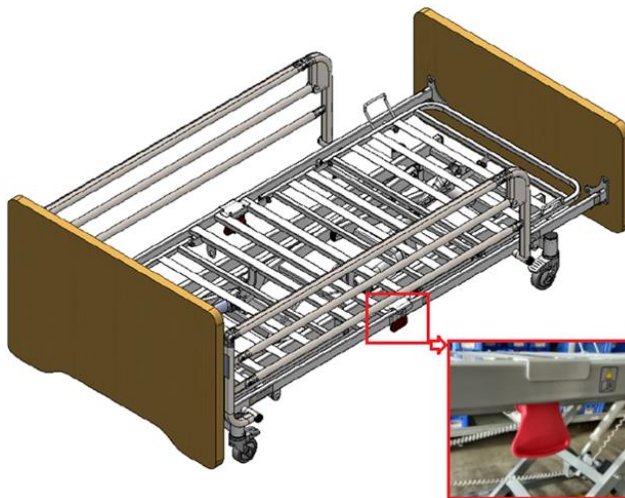

Warning

There is the risk of injury to the upper limbs when lowering the back section with the CPR system. Before pulling the handle, make sure that there are no objects or limbs between the back section and the frame elements it rests against when folded.

9. DISASSEMBLING THE BED FOR TRANSPORT



Warning

- Before attempting to disassemble the bed ensure these instructions have been read and fully understood.
- Ensure a risk assessment in line with local health and safety policy is undertaken to ensure that staff are not put at risk when performing disassembly activities.
- Pay special attention when disassembling the bed - individual sections of the bed are heavy - see section 15.1 for the weight of individual parts.

Side rails

- Raise / lower the bed to approximately its middle height - make sure that the mattress's platform is levelled.
- Raise the side rails to its highest position.
- Remove the retaining screw from one of the channels.
- Lower the side rails at this end with care until the finger assembly disengages from the channel.
- Carefully remove all side rails.
- Relocate the finger assemblies into the channel (see section 6.3).
- Re-fit the retaining screw into the channel.
- Repeat for the other side of the bed.

Note: Do not disassemble the Light side rails, or the split side rails! For transport these side rails should be lowered to the lowest position.

Bed Ends

- Unfasten the grub and dome screws from both end of the bed.
- Remove both bed ends from spigot and put them gently aside.
- Repeat for the remaining bed end.

Electrics

- Flatten and lower the bed and the whole mattress platform to its minimum height.
- Unplug the mains cable from the mains socket.
- With cable ties (or similar), secure the moving parts of the backrest and leg section to the bed frame.
- With cable ties (or similar), secure all cabling and ensure is not dragging on the floor or is under excess tension.



- The bed cannot be transported if any fixing is missing, or any part of the bed is not fully secured with cable ties or similar - risk of the bed collapsing.
-
- Make sure that moving parts were secured with cable ties, stretch foil (etc.) – the risk of uncontrolled movements of individual sections during transport.
- During transport hold only the constant parts of bed construction.

10. POWER FAILURES

The bed **can be equipped (optionally)** with additional emergency power supply – Backup System, that enable to lower the backrest and leg sections in the event of a power failure. If the bed is not equipped with an auxiliary power supply, in the event of a power failure, the electrical functions will not work. This will cause that the backrest section and/or leg section, as well as the position of the mattress platform will remain in their last observed position (e. g. in a raised position).

Backup System is an auxiliary power device in the MCL II control box that is directly connected to the control box. In the event of a failure/power failure the system enable to control the bed's functions for a limited period of time. The bed's functions may run slower due to the power supply from batteries.

Backup power systems are continuously charged when the bed is connected to the mains supply in order to keep them constantly charged. The bed will operate normally while charging. There is not audible or visual signal, which would indicate that the system is charging or used.



Make sure that the backup power system is not exposed to direct sunlight or other heat source – direct heating of the battery by an external heat source may result in a risk of fire or explosion.



Do not use the emergency power system during normal use (i. e. when the bed is disconnected from the mains) – due to the risk of shortening the battery life.

10.1. EMERGENCY LOWERING BACKREST AND LEG SECTIONS

The backrest and knee break are operated via two individual actuators that are located underneath the mattress platform. In the event of power failure and the need to lower please follow the steps below:

- If either the backrest or leg section is raised, locate the actuator supporting the relevant section.
- Address another person for assistance in holding the relevant section.
- Remove the pin that holds the bolt in place (**only on one side!**).
- Remove the bolt that holds the actuator (**only on one side!**).
- Remove the piston by placing it gently on the floor – it can hang down.
- Gently lower the section to the level position.

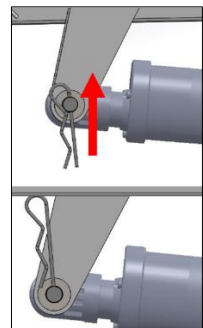



- If the section should be lowered while the patient is in the bed, a risk assessment consistent with local health and safety regulations ought to be carried out in order to determine if it is possible to levelled the section with the load in a safe way.
- **When the pins are removed there is nothing supporting the section, the person holding the frame must be ready to support the section weight.**
- It is recommended that 2 persons perform the operation.
- Beware of objects and body parts crushed between the bed headrest and platform frameworks.

11. DECONTAMINATION

Infection control and routine cleaning must be carried out in accordance with the Infection Control Policy, the local infection control schedule or recommendations from the local regulatory authorities.



- Always disconnect the bed from the main power supply prior to cleaning.
- Ensure all ports on the electrical system (control box and actuators) have cable plugs inserted to maintain the IP rating.
- Regular cleaning and disinfection of the bed frame and relevant accessories will help to prevent the risk of infection to the occupant and / or carer.
- Prior to transferring the bed frame / accessory to another user ensure it has been cleaned and disinfected using the method as detailed below to help prevent the risk of cross infection.

Before the beginning of disinfection and cleaning operations it is advisable to remove any accessories that are fastened to the bed.

These instructions apply to all accessories (with the exception of mattresses).

General cleaning:

- The bed should be cleaned by starting with the cleanest parts of the bed and systematically moving to the dirtiest parts. Extra care should be taken around areas where excess dirt or dust may gather.
- The cloth should be changed during the cleaning process if it becomes soiled.
- Wipe down with a clean cloth moistened with a mild detergent and dilute with warm water (40°C).
- Rinse with cold, clean water and a clean cloth, and allow to fully dry before use.

Decontamination:

- Mop up any fluid with paper towels.
- Wipe bed down using cold clean water.
- Wipe down with a 0.1% Chlorine solution (1,000 ppm) in cold water.
- Rinse with cold clean water and a clean cloth and allow to fully dry before use. Always ensure the cleaned parts are allowed to dry before putting the mattress back in place.

In cases of blood spills or other bodily fluids it is recommended that a 1% Chlorine solution (10,000 ppm) is used instead. Ensure fabric surfaces are rinsed with clean water after application.

Note: If any of the stages stated above are omitted or combined it will reduce the effectiveness of the clean.

Note: The use of neat bleach or similar surface cleaners is not recommended as damage may be caused to the cleaned surfaces.



- During decontamination use appropriate protective cover to minimize contact of these measures with the skin. Always check what neutralizing agent is recommended by the manufacturer.
- Decontamination procedure performed by an unauthorized person pose a threat to the person as well as the environment.
- The bed manufacturer assumes no responsibility for any loss or damage caused by improperly conducted decontamination.
- Pay special attention to the decontaminator does not get into the electronic system, sockets and other electrical components - the possibility of a short circuit.

12. MAINTENANCE

Only authorised service personnel or Reha-Bed sp. z o.o. service engineers should carry out repairs or service activities. The manufacturer is not liable for unauthorised repairs. Failure to observe the rule may result in the manufacturer's warranty becoming void. Service activities may be performed by any trained person or service personnel. **The bed must be serviced annually, as a minimum.**

The manufacturer also recommends that the care person performs frequent visual and operational inspections. If there are any signs of damage or the bed is not performing as it should, it should be withdrawn from service until the bed has been repaired and is fit for use again.

Periodically check to ensure that:

- No parts are missing.
- All fixtures and fittings are tight.
- No parts show signs of excessive wear (including no cracks near welded areas).
- The electrical components display no sign of damage - If so turn off at the mains and remove the bed from use immediately.
- The frame is mechanically operational.
- The bed operates as per its intended purpose.
- The bed is cleaned following the guidelines in this Instruction Manual.
- All accessories and additional equipment are fitted in a right way.

12.1. GENERAL MAINTENANCE

The manufacturer recommends that the beds are serviced **once yearly, as a minimum**. Please act accordingly with the following instructions:



- Failure to perform inspections at the recommended frequency could adversely affect the basic operation of the bed and (consequently) put the patient at risk.
- Always disconnect the bed from the main power supply prior to performing any maintenance procedures (with the exception of checking electrical functions of the bed).
- Modification of the bed frame is not allowed without the permission of the manufacturer - A hazard could be introduced.
- The bed should be vacated by the patient before any maintenance or inspection takes place. If this is not possible due to the patient's mobility, care should be taken for the service engineer not to make contact with the patient when working on electrical items.
- Electrical system components are only to be replaced by authorised service personnel or service engineer.



- Only manufacturer approved components, specified for the Leo bed, should be used - if in doubt contact your local distributor, importer or manufacturer.
- Never attempt to re-wire any components.
- Over time, the auxiliary emergency power supply may emit an increased amount of flammable gas, creating a risk of explosion/fire. Reha-Bed sp.z o.o. recommends replacing the batteries every 4 years or earlier.

- Check if all electrical functions operate correctly.
- Check if all electrical cables are in good condition.
- Check if the mains cable and plugs are in good condition, if either is damaged it must be replaced as a complete assembly, the plug or cable must never be re-wired.
- Check if cover protecting the actuator plugs and the power cable plug in the control box is fitted.
- Check if all nuts, screws and fasteners are tight and that none are missing or incomplete.
- Check if all screws and knobs are present.
- Check if the backrest section is mechanically operational.
- Check if the leg section (including the knee break functions) work correctly.
- Check if all labels and stickers are present and legible.
- Raise and lower the side rails – check if they move smoothly.
- Check if aluminum channels at the bed ends operate correctly.
- Check if the lock on the side rails automatically engages when raised.
- Check if the castors lock function works correctly and that when locked castors do not move.
- Check if the bed's frame does not show signs of excessive wear (in particular whether there are no cracks near welds).
- Check the condition and voltage of the batteries for the emergency power system. It is recommended to replace them when the battery condition or nominal voltage is abnormal.
- If any gaps appear to be outside of specification remove the bed from use until the dimension of the gap in question has been confirmed.

If in doubt about correct replacement of a component contact your local distributor or seller. Refer to the parts list for part codes and assembly detail. Copies are available from your local distributor or importer. Contact details can be found in section 1.1 of the booklet.

12.2. SERVICE LIFE

The service life of the Leo bed is 10 years*, with the exception of the mattresses. On the basis that the bed and its associated accessories are serviced and maintained in acceptance with the information detailed in these instructions for use and the individual instructions provided with the accessory in question.

At the end of service life, the bed should be withdrawn from use in accordance with local waste management policy.

*Not applicable to the electrical components – see section 15.4.

12.3. FAULTY FINDING

Listed below are a set of electrical faults that may occur within the service life of the bed. If a fault does occur please try the following suggestions, as these may help in diagnosing the fault, or contact the service department.

Fault	Possible cause	Remedy
Electrical function(s) do not work	Functions locked out on handset	Unlock functions with a mechanical key (see section 8.6.3)
	Mains cable not plugged into the control box or socket	Check to see if the 'power on' light on the handset is on and the mains cable is plugged in at both ends
	Fuse blown in the mains plug	Check to see if the 'power on' light on the handset is on, if not turn off the device, unplug the mains cable and contact the approved service department
	Actuator / handset cables not plugged in	Check plug connections on the control box
	Damage to mains cable, actuator cable or handset cables	Turn off the device, unplug the mains cable and contact the approved service department
	Work cycle of the control box has been exceeded – possible permanent damage	If the control box has exceeded its duty cycle permanent damage may have occurred. Allow power supply to cool for 20-30 minutes before attempting to re-operate. If electrical functions still do not work a replacement power supply and/or control box will be required
Electrical functions working slow	Heavy load on the bed	Remove load
	The bed is powered by an emergency power system	Check that the power cable is connected at both ends and check that the power indicator illuminates on the handset
Incorrect functions operate while controlling the handset	Actuator plugs are plugged into the bad ports in the control box	Check that the connected cables correspond to the markings on the control box – correct connection is described in section 6.1
The bed instable	Grub screws loose	Tighten grub screws



Warning

During the adjustment and maintenance attention should be paid to ensure that no part of the body is found in the potentially hazardous section (movable: headrest section, leg section, high / low system, side rails).

13. DISPOSAL OF PARTS

When the bed frame / electrical system has come to the end of its useful life follow local recycling and W.E.E.E. (Waste Electrical and Electronic Equipment) policies.

The electrical system on the bed frame is not to be disposed of in general municipal waste. Some of the electrical components could be harmful to the environment and where viable the components can be recovered and reused / recycled.

The steel, plastic and wooden components are also to be separated and disposed of following the local recycling policy as these can also be recovered and recycled.



The bed is to be decontaminated before disposal to avoid risk of cross contamination.

14. ELECTROMAGNETIC COMPATIBILITY (EMC)

The electrical system has been designed to meet the necessary EMC requirements (IEC 60601-1-2 standard) however it may still be affected by or emit harmful radio frequency (RF) energy. The RF emissions from the electrical system are very low and are not likely to cause any interference to nearby electronic equipment, however interference to sensitive equipment is still possible. Likewise, if the immunity limits of the electrical system are exceeded the system may be seen to operate abnormally.

Interference can be received from fixed transmitters (e.g. commercial radio and television towers) and portable / mobile RF communications equipment (e.g. mobile phones). Due to the increasing number of mobile phones and other wireless devices the possibilities of interference to the electrical system and other surrounding equipment results in the need for special precautions to be taken regarding EMC.

If the bed or any alternative equipment is found to be operating abnormally turn off the piece of equipment that is believed to be causing the interference (if possible) to identify the source of the RF energy. Once identified mitigation measures are to be taken, such as the separation distances being increased and / or the device(s) being re-orientated.

If the bed continues to operate abnormally disconnect it from the mains supply and contact your local distributor or importer.



- The bed should not be used adjacent to or stacked with other medical electrical equipment, where viable. If adjacent or stacked use is necessary, the bed and associated medical electrical equipment should be observed to verify normal operation - If not taken into account abnormal operation could occur.
- The use of accessories and cables other than components specified or provided by the manufacturer may increase the electromagnetic emission of the bed and cause malfunction.
- Portable RF communications equipment (including peripheral devices – such as antenna cables and external antennas) should not be used closer than 30 cm from any part of the bed (including cables). Otherwise, performance may be deteriorated.

15. SPECIFICATION

15.1. BED DATA

	Leo L	Leo S	Leo M	Leo Wide	Leo with with integrated length extension	
Overall length [mm]	2060	2060	2060	2075	2060/2260	
Overall width [mm]	1050	1070	1070	1270	1070	
Mattress platform height range [mm]	315 - 785			300 - 770	315 - 785	
Under bed clearance (up to the metal frame) [mm]	145			130	145	
Mattress platform length [mm]	2000				2000/2200	
Mattress platform width [mm]	900			1100	900	
Backrest section tilt [°]	68					
Thigh section tilt [°]	28					
Calf section tilt [°]	21					
Maximum calf section height [mm]	140					
Trendelenburg tilt [°]	0 - 15					
reverse-Trendelenburg tilt [°]	0 - 17					
Part weights [kg]	Mattress platform	35,6			49	38,6
	Bed lift	50			48	50
	Bed end (each)	8,7			10,2	8,7
	Side rails (set)	10,5	21,8	13	10,5	21,8
Overall bed weight [kg]	103			117,4	106	
Overall bed weight with side rails [kg]	113,5	124,8	116	127,9	127,8	

Particular dimensions and weights may vary depending on the version of the bed and accessories. The bed data identify the maximum angles which can be achieved in normal use by each part of the mattress support platform with reference to horizontal. Mattress platform height is defined as the maximum and minimum height from the floor which can be achieved by the mattress support platform in normal use.



Warning

If patient requirements are such that Trendelenburg functionality is deemed to pose a potential risk a replacement handset can be purchased with the Trendelenburg function removed.

15.2. MAXIMUM LOAD

	Leo	Lifting pole
Safe working load	215 kg	80 kg
Maximum User weight	178 kg	-

The safe working load is the sum of the weight of: patient/user, mattress, accessories, loads carried by accessories (excluding the patient's weight).



Warning

The above-listed maximum loads refer to a bed used by one person only. The bed is not designed to carry the weight of guests seated at the side of the bed. Additional weight can damage components or make the bed unstable – creating a risk of injury.

15.3. TECHNICAL DATA OF SIDE RAILS

Leo bed has been tested and approved with wooden side rails along the entire length of the mattress platform, the Light side rails and the split side rails. The table below presents the basic dimensions of side rails that can be used with the bed.

WYMIARY PORĘCZY (1 szt.)	Length x Height x Width [mm]	
Standard wooden side rails*	1986x85x28; 1986x95x28; 1986x100x28; 2175x95x28**; 2175x100x28**;	
Light side rails (when raised)	1515x435x45	
Split side rails (when raised)	Head end side rail (short side rail)	770x420x25
	Foot end side rail (long side rail)	1155x420x25

* The dimension depends on the selected bed option

** To be used only with bed extension.

The manufacturer recommends the use (only) the manufacturer's side rails along with their beds. The manufacturer does not recommend the use of Leo bed with side rails for patients with a height of less than 146 cm – the equipment supplier is responsible for ensuring the suitability for use.



Warning

- Despite the fact that the manufacturer made every effort to ensure that the design of side rails meets the appropriate safety standards, side rails may still pose a potential risk of death resulting from entrapment and/or suffocation.
- Persons responsible for the sale/purchase, selection for use and adjustment of side rails, should be aware of the potential risk regarding entrapment and/or suffocation when the bed is in use.
- When positioning and adjusting the side rails, make sure that all spaces between side rails, mattress and bed frame will not block the patient's head and body. Furthermore, the size and physiological condition of the patient should be considered. Conduct an assessment in order to ensure that the gaps between side rails are not large enough to create a potential risk of entrapment and/or suffocation. All persons responsible for the patient care must be aware that increased vigilance is required when a patient lies on the bed with side rails.



Caution

Only medical mattresses may be used. The use of other types of mattresses may damage the bed.

15.4. ELECTRICAL DATA

	MCL II control box
Voltage in:	100 – 240V, 50/60 Hz
Current in:	Max. 3,15A
Electric shock protection:	Class II

Duty cycle:* 10%
2 mins of continuous use followed by **18 mins** not in use
 5 switching cycles per minute

*Electrically operated beds are intended to be operated intermittently rather than continuously. If the bed is operated continuously for up to 2 minutes it must then be left for at least 18 minutes before reuse to allow the electrical system to cool sufficiently. If the bed is continuously used for an extended period of time and it exceeds the duty cycle the control box may become temporarily disabled or irreparably damaged.

No more than two drives may be operated at rated load simultaneously!

Safety standards: IEC 60601-1: 2005
 IEC 60601-2-52:2009
 IEC 60601-1-11:2010

Applied part electrical shock protection: Type BF

Applied parts: Mattress platform
 Profiling sections
 Bed ends
 Handset
 Side rails

Liquid ingress protection: IPX4 – Splash resistant

Noise level: 67dB(A)

Service life: 5 years

Environmental conditions:

	Operational Limits*	Transportation/storage limits
Ambient temperature:	+10°C to +40°C	-20°C to +50°C
Humidity:	30% - 75%	30% - 75%
Atmospheric pressure:	800 to 1060 hPa	800 to 1060 hPa
Altitude:	≤ 2000 m	≤ 2000 m

* Always ensure the bed is brought up/down to room temperature before plugging in and operating. It is recommended to leave the bed for at least 2 hours in order to ensure that it reaches room temperature.

16. ACCESSORIES

The Leo bed has been tested and approved with the following accessories:

	LEO L	LEO M	LEO S
Lifting pole with plastic handgrip	✓	✓	✓
Bed extension (+mattress extension)*	✓	✓	
Bed extension with wooden slat (+mattress extension)*	✓	✓	
Bed extension with wooden slat for bed with split side rails (+mattress extension)*			✓
Height extension (optional wooden side rail fitted up standard rails)*	✓		
Drip holder	✓	✓	✓
Urological bag holder	✓	✓	✓
Grab rail (holder that supports standing)*	✓	✓	
Grab rail external (holder that supports standing)*	✓	✓	
Tablet*	✓		
10-button handset	✓	✓	✓
Emergency power supply - Backup System	✓	✓	✓
CPR System	✓	✓	✓

* Always consult the supplier or manufacturer on the possibility of using the selected accessory with your version of the bed.

Characteristics of the accessories can be found in the relevant accessory's instructions for use.

The manufacturer cannot be held responsible for any injury or incident which relates to the use of any product combinations not approved by the manufacturer.

It is the carer's responsibility for selecting and fitting the products correctly and ensuring that the product combination is compatible. In the case of doubts, please contact the supplier or the manufacturer.



Warning

- It is forbidden to use accessories that have not been approved or are not intended for use with the bed – the risk of danger due to incompatibility regarding the combination of products.
- The manufacturer is not responsible for any injuries or incidents connected with the use of unapproved accessories.



- Pay particular attention when raising/lowering side rails – if a grab rail is applied – the space between these two components may pose a risk of crushing fingers.
- Take care when raising the back section in combination with the grab rail, because the space between these two elements may pose a risk of finger(s) entrapment.
- If the height extension for side rails is used along with a foam mattress, make sure that the patient’s entry/exit is not difficult – otherwise, during the change of the patient’s position, remove and reinstall the height extension (as required).

16.1. MATTRESS AND SIDE RAILS

Leo bed has been tested and approved with listed below mattresses. The mattresses listed below are mattresses recommended by the manufacturer. Contact your distributor, importer or manufacturer to select a mattress suitable for your bed.

Mattresses have been tested and approved with side rails characterized by specific dimensions dedicated to the Leo bed (see section 15.3).

	Dimensions [mm] <i>width x length x thickness</i>	Density [kg/m³]
Foam Mattresses		
Hyper Foam Plus	800x2000x140; 850x2000x140; 900x2000x140; 1100x2000x140	35/38*
Hyper Foam 2	800x2000x150; 900x2000x150; 1100x2000x150	35/45/50*
Hyper Foam Maxx 250	900x2000x140; 1100x2000x180	35/50/50*
Hyper Air Hybrid	900x2000x160	35/50+50/38*
Memocare	900x2000x140	33/35/50*
EVAQ-PRO	900x2000x140; 900x2000x150	35/38*
Waffle Mattress	780x2000x120; 850x2000x120; 900x2000x120; 900x2000x150; 1100x2000x150	25
Waffle Mattress	850x2000x140	35
Waffle Mattress with HR filling	780x2000x120 850x2000x120; 900x2000x120; 900x2000x150	35
Foam Mattress	780x2000x120; 800x2000x120; 850x2000x120; 900x2000x100; 900x2000x120; 900x2000x150; 900x2000x200; 1100x2000x120	25
Foam Mattress	900x2000x120; 900x2000x150; 1100x2000x150	35
Foam Mattress with HR filling	900x2000x150	35
Mattress extension	780x200x120; 900x200x120; 900x200x140; 900x200x150	25

** The values refer to the density of individual layers of mattress.*

Other mattresses available upon request – contact your seller or the manufacturer to check for compatibility and suitability purposes.



- Mattresses and side rails not approved by the manufacturer pose a risk of entrapment for the bed user.
- The manufacturer deems the listed above foam mattresses to be suitable for use with the Leo side rail, however a patient risk assessment must be performed to ensure the gap between the top of the mattress and top of the side rail when fully lowered is acceptable and will not introduce a hazard to the patient when entering/exiting the bed.
- If the dynamic mattresses are used without side rail height extensions a patient risk assessment must be performed to ensure the gap between the top of the mattress and top of the side rail when raised is acceptable and will not introduce a hazard to the patient.
- If the dynamic mattresses are set to a low pressure the gap introduced by cell compression at the mattress edge and the side rail is to be considered. A patient risk assessment must be performed to ensure an asphyxiation risk is not introduced.
- Make sure that the applied mattress is characterized by the correct size and type and that it is positioned in a right way on the bed. The mattress should be placed between mattress holders on sides of the mattress platform sections – an incorrect mattress may pose a risk of entrapment and/or fall of the patient.
- Make sure that side rails and mattress are correctly selected – incorrect selection of products may pose a risk of entrapment.



- Make sure that the control box of the dynamic mattress is not placed on side rails – risk of damage by falling when/after lowering side rails.
- It is essential that dynamic mattress straps are only attached to the moving parts of the profiling mattress platform. If the straps are incorrectly fitted around the main section of the mattress platform, serious damage could occur to various components of the bed. If in doubt contact your local provider or the manufacturer.



17. LIFTING POLE

Optionally, the bed can be equipped with a lifting pole with a triangular handle with an adjustable length of the belt. In order to install the lifting pole:

- Lock all 4 wheels.
- Select one of the two lifting pole sockets located at the corners of the mattress platform (on the head bed end).

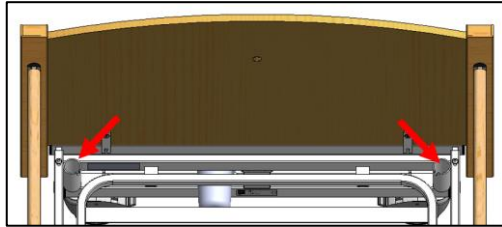

- Place the lifting pole in the selected lifting pole socket. **Note!** Make sure that the positioning pin is placed in the positioning groove.
- Place an adjustable belt with a triangle handle on the lifting pole. Make sure that the grip belt is located between positioning pins.

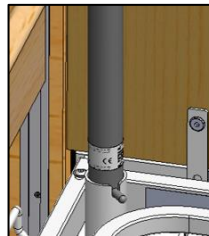
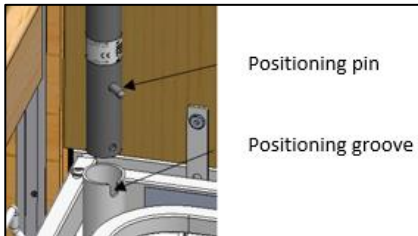

Warning

- Installation of the lifting pole **in a place that is not intended for this purpose** poses a risk of damage to health or an accident.
- In order to ensure the user's safety while using the lifting pole, make sure that the lifting pole has been properly installed.

18. WARRANTY

The warranty period is 24 months from the date of purchase of the bed. The warranty does not cover mechanical damage and interference with the bed's structure, actuators or the bed's control box. In the absence of regular inspections, the guarantor is not responsible for any damage resulting from this fact. The warranty card is attached at the end of the instruction manual

18.1. WARRANTY CONDITIONS

1. Reha-Bed Sp. z o.o. guarantees the efficient operation of medical equipment for 24 months from the date of purchase – in acceptance with the technical and operational conditions described in the instruction manual.
2. Upon recognition of a defect or damage to the product within the warranty period, they will be removed free of charge within 14 working days from the date of reporting and marking the product available for repair.
3. The user is not obliged to deliver the product weighting more than 1 kg and large dimensions (e. g. product's size exceeding 3m²).
4. If the user fails to deliver the product with the complaint card, the deadline for processing the complaint (set in point 3 above) is calculated from the date of inspection of the product covered by the complaint.
5. The guarantor is released from liability for damage to the product caused by inadequate use or use inconsistent with the instructions for use (e. g. storage, maintenance, broken seals, mechanical damages).
6. The concept of repair does not include actions determined in this instruction manual, which should be carried out by the user on his own.
7. The warranty is extended for the period, during which the product is under repair. If a defect (as a defect covered by the warranty) is not found during the complaint procedure, all costs connected with transport/travel, work of a service technician, as well as costs related to spare parts and materials are covered by the buyer (the product's owner).
8. The warranty does not cover wear and tear of the product resulting from its normal use and ongoing maintenance of the product (e. g. cleaning, tightening of set screws, as well as steps determined in this instruction manual).
9. The warranty does not cover missing bolts, nuts, etc., resulting from the lack of maintenance.
10. Replacement of the advertised product or its part with a new one – free from defects – does not extend the warranty period.
11. The product for the repair should be cleaned. Cleaning is not included in the scope of warranty repair work. If the product is not cleaned, the manufacturer reserves the right to invoice the service connected with the cleaning of the product or not to perform a warranty repair and return the product at the expense of the claimant.
12. Loss of warranty rights takes place in the following cases:

- a) It is not possible to identify the product from the serial number and production date on the bed.
- b) The product has been used in a manner inconsistent with the manner described in the instruction manual. The product has been used for other purposes or in conditions other than the intended ones.
- c) There has been an interference with the product, including repair of the product by an entity other than the manufacturer or authorized service of Reha-Bed.
- d) The product has been mechanically damaged (e. g. fall, hit, breaking the railings by leaning or sitting on the product, etc.).
- e) The product was damaged as a result of external factors – e. g. through contamination, flooding of actuators or the control box, use of the bed in inadequate conditions and if the product was damaged due to the user's fault (e. g. during the use of a damaged product or inappropriate equipment, overloading the bed, etc.).
- f) The product was used despite the defect.
- g) The product was damaged during transportation.
- h) The product (delivered for repair) is incomplete.
- i) Non-compliance with notes and warnings presented in the instruction manual.

Consideration of the complaint refers only to products placed on the market by the manufacturer – Reha-Bed Sp. z o.o.



REHA-BED Sp. z o.o.
ul. Spacerowa 1
41-253 Czeladź
phone (+48 32) 346 00 33
fax. (+48 32) 346 00 34
biuro@rehabed.com.pl

INSTRUC/LEO/EN, 2023/05 REV3